

20L paint bucket mold

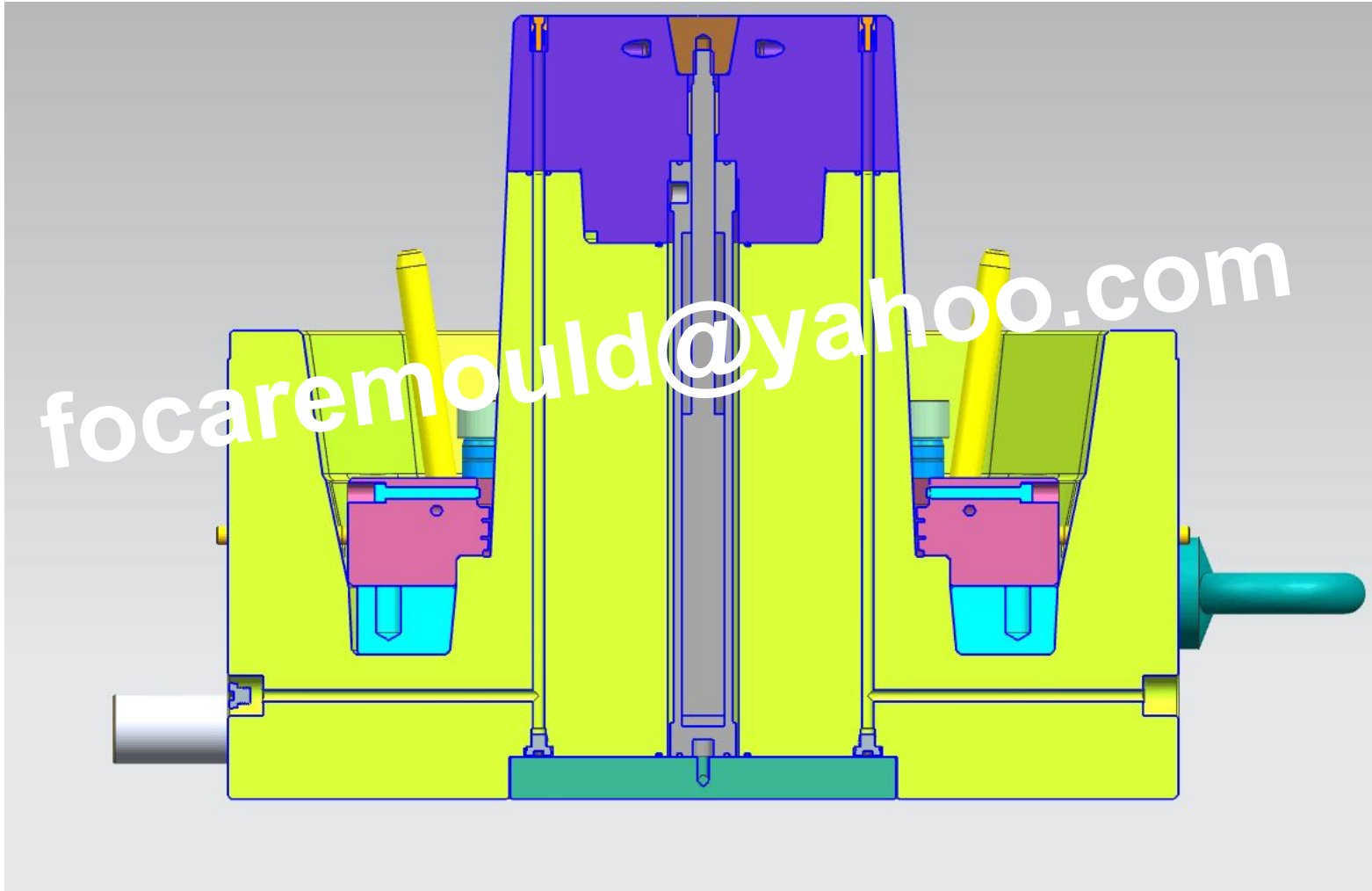

20L paint bucket mold

ejecting system



20L paint bucket mold

Regular hexagon design
make mold much more easier
for maintaince.

focaremould@yahoo.com

put wear plates on all surfaces
might be worn easily for
durable mold lifetime

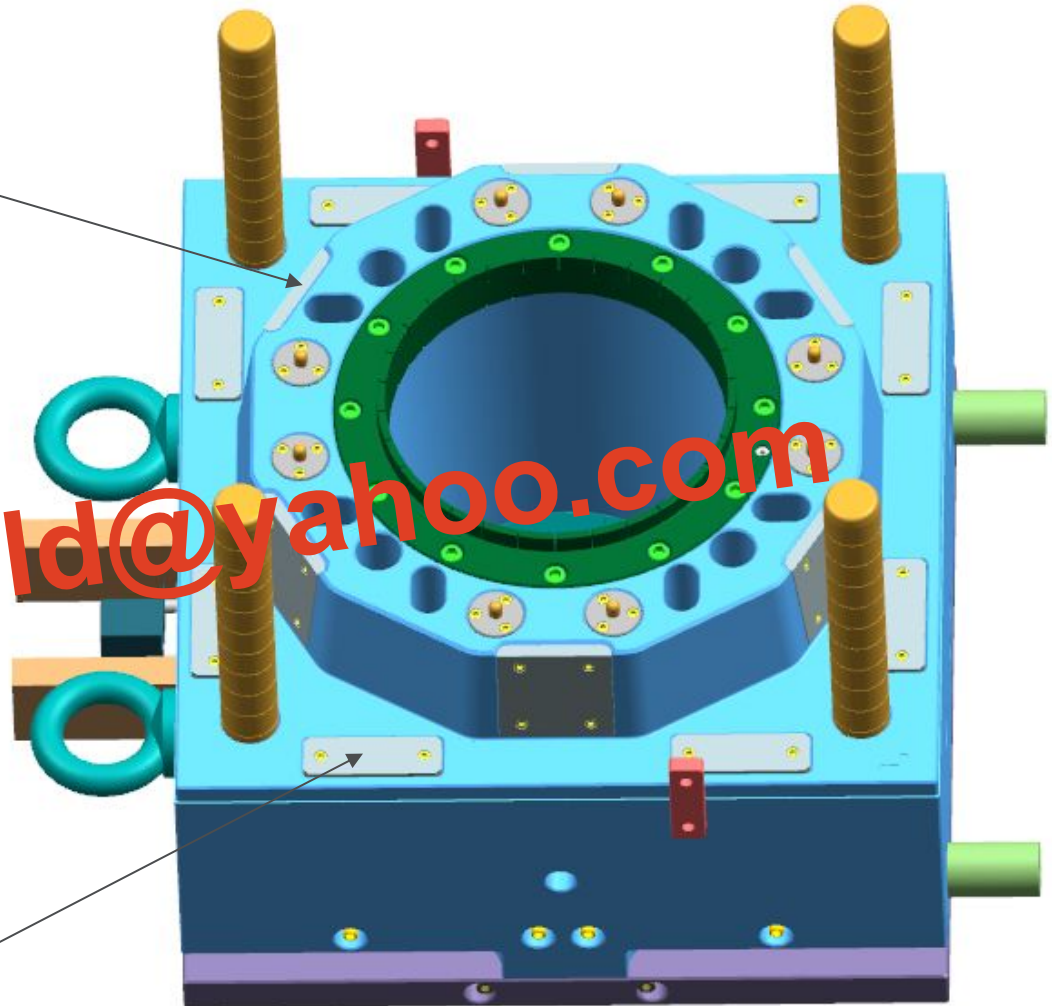

cavity inserts

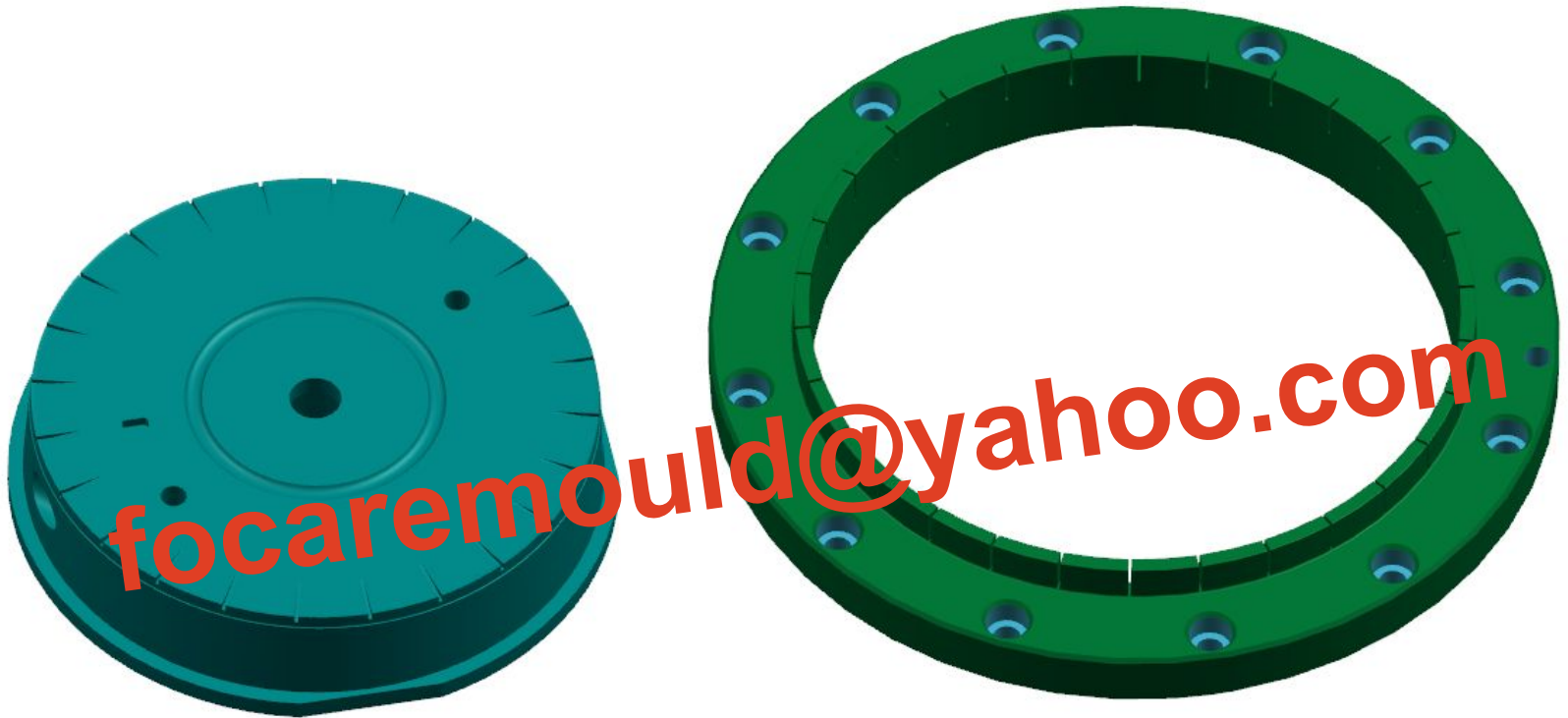

20L paint bucket mold

cavity cooling

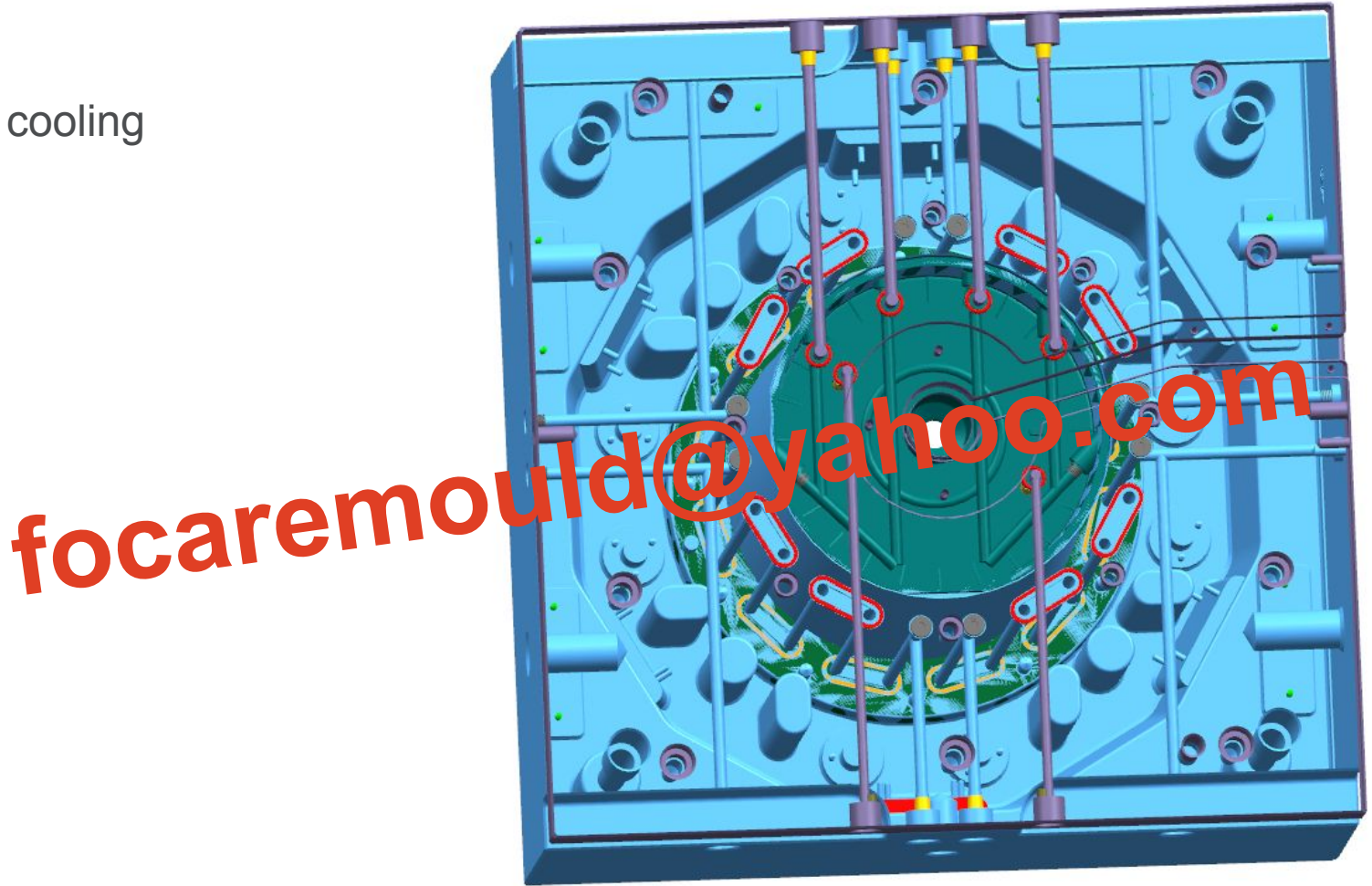

20L paint bucket mold

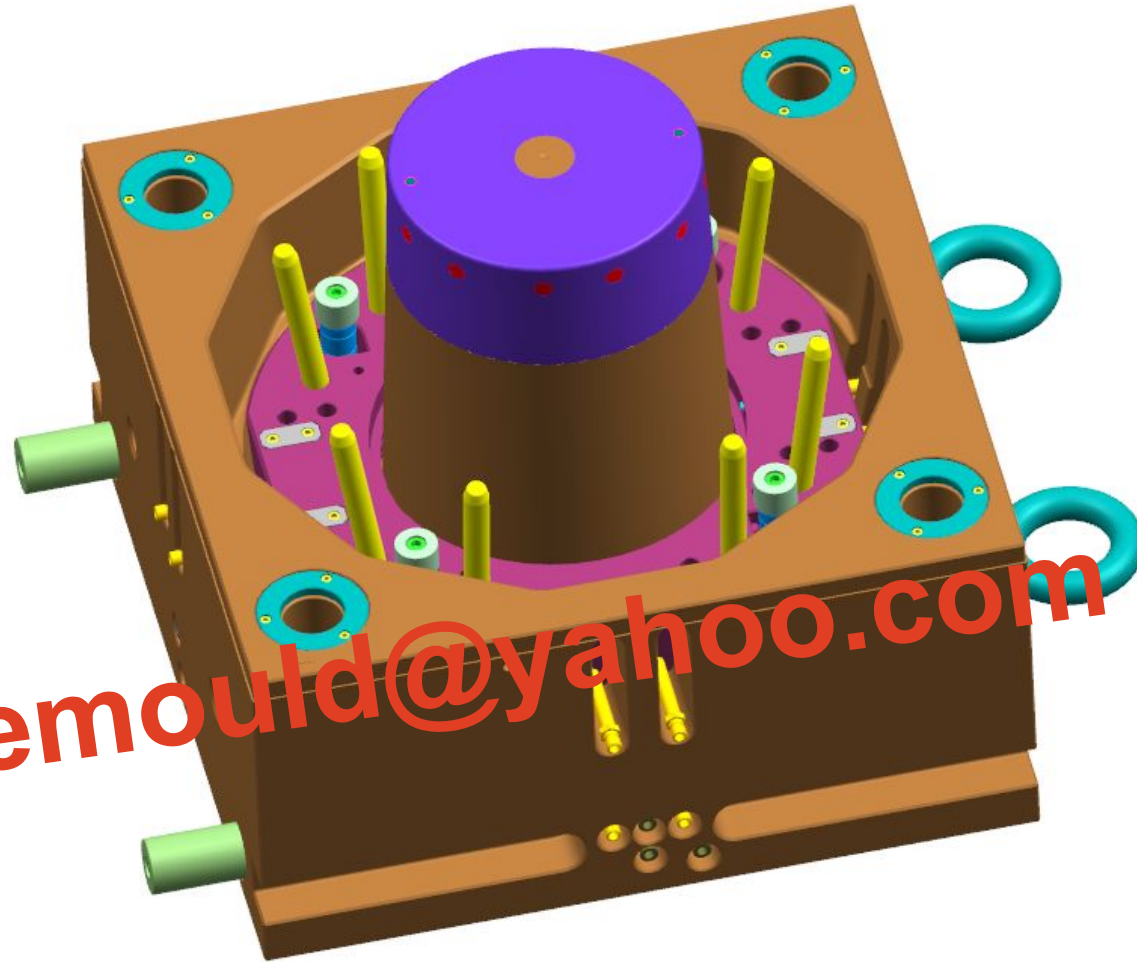

focaremould@yahoo.com

20L paint bucket mold

core inserts

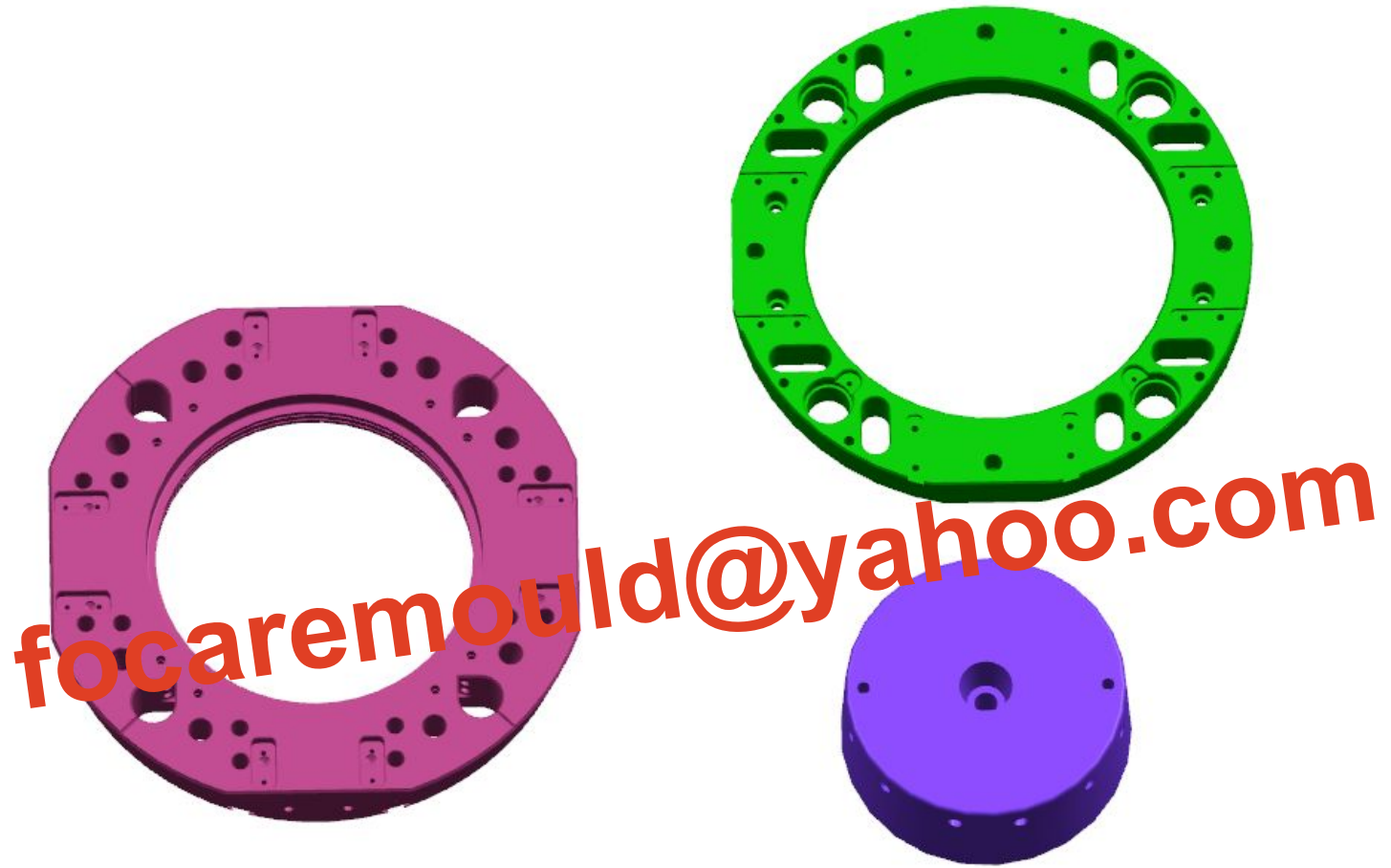

20L paint bucket mold

insert cooling



20L paint bucket mold

core cooling



focaremould@yahoo.com

20L paint bucket mold

Optimized cooling system to reach minimum cycle time.

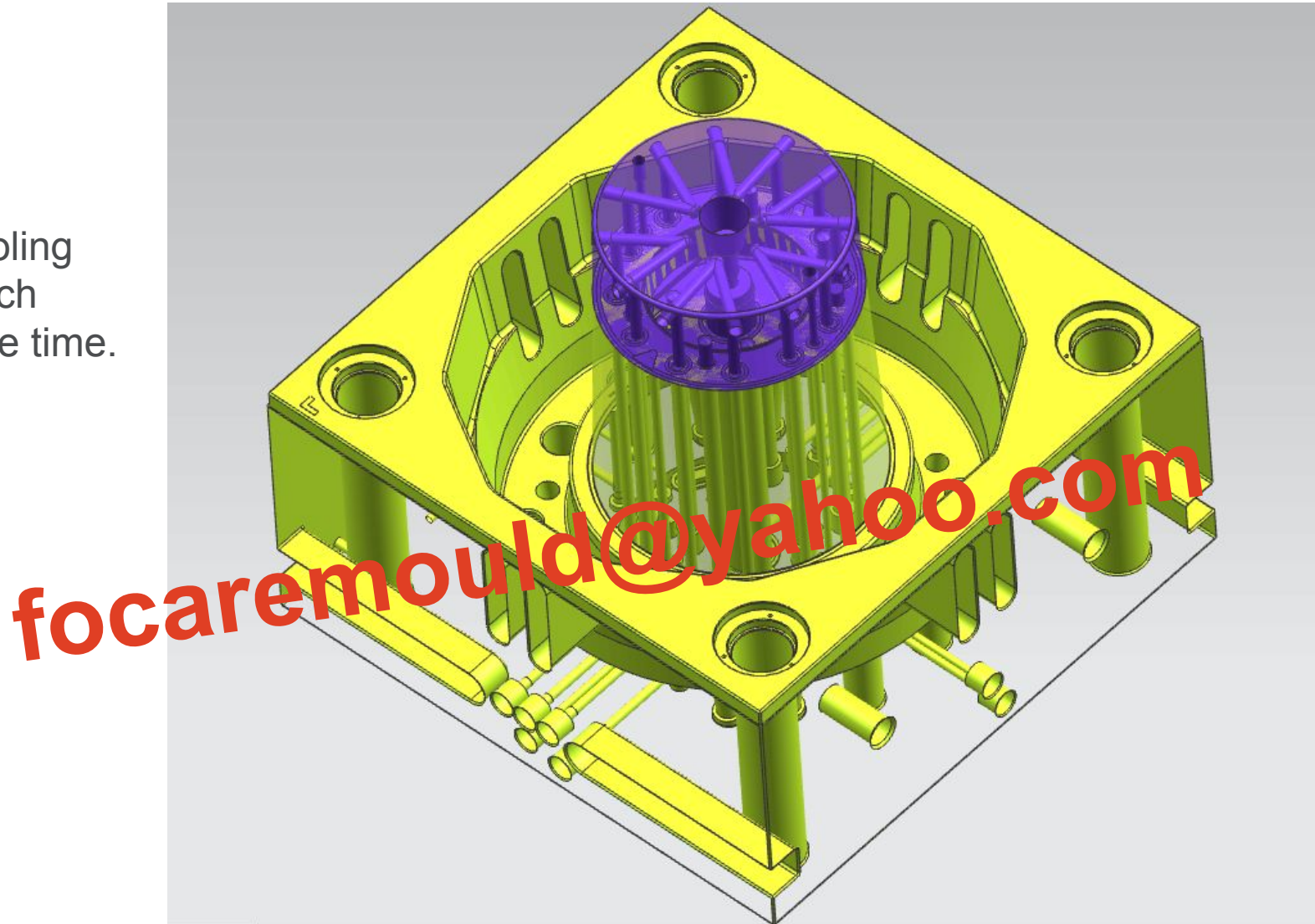

20L paint bucket lid mold

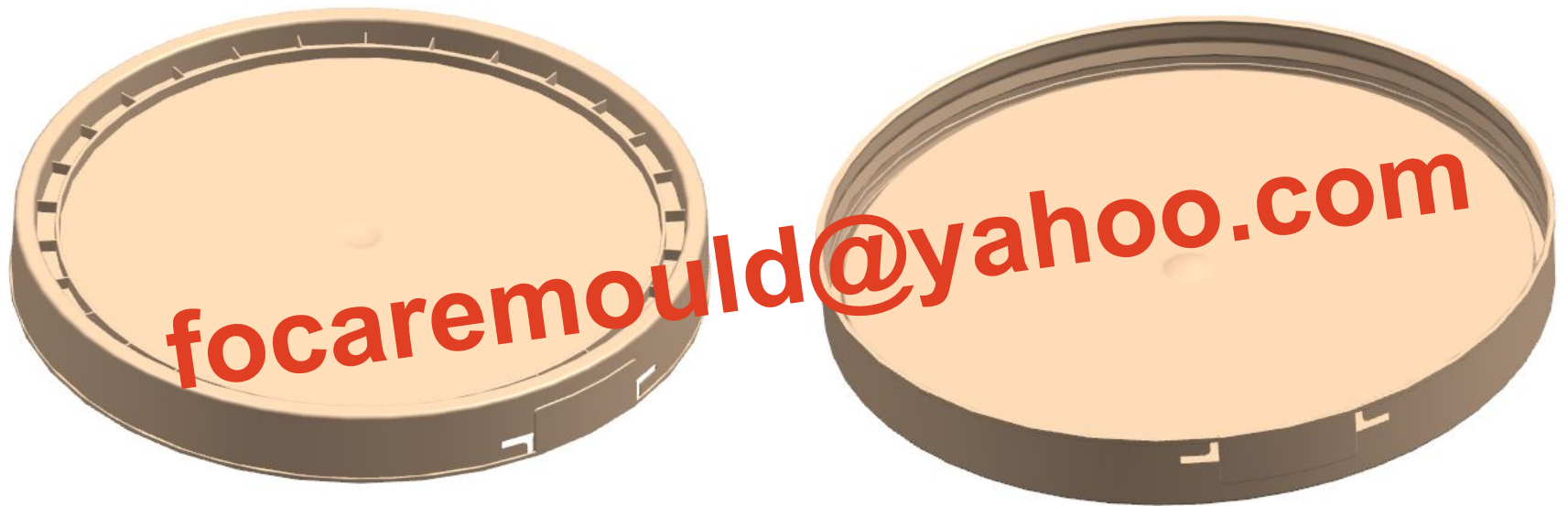

20L paint bucket lid mold

ejecting system

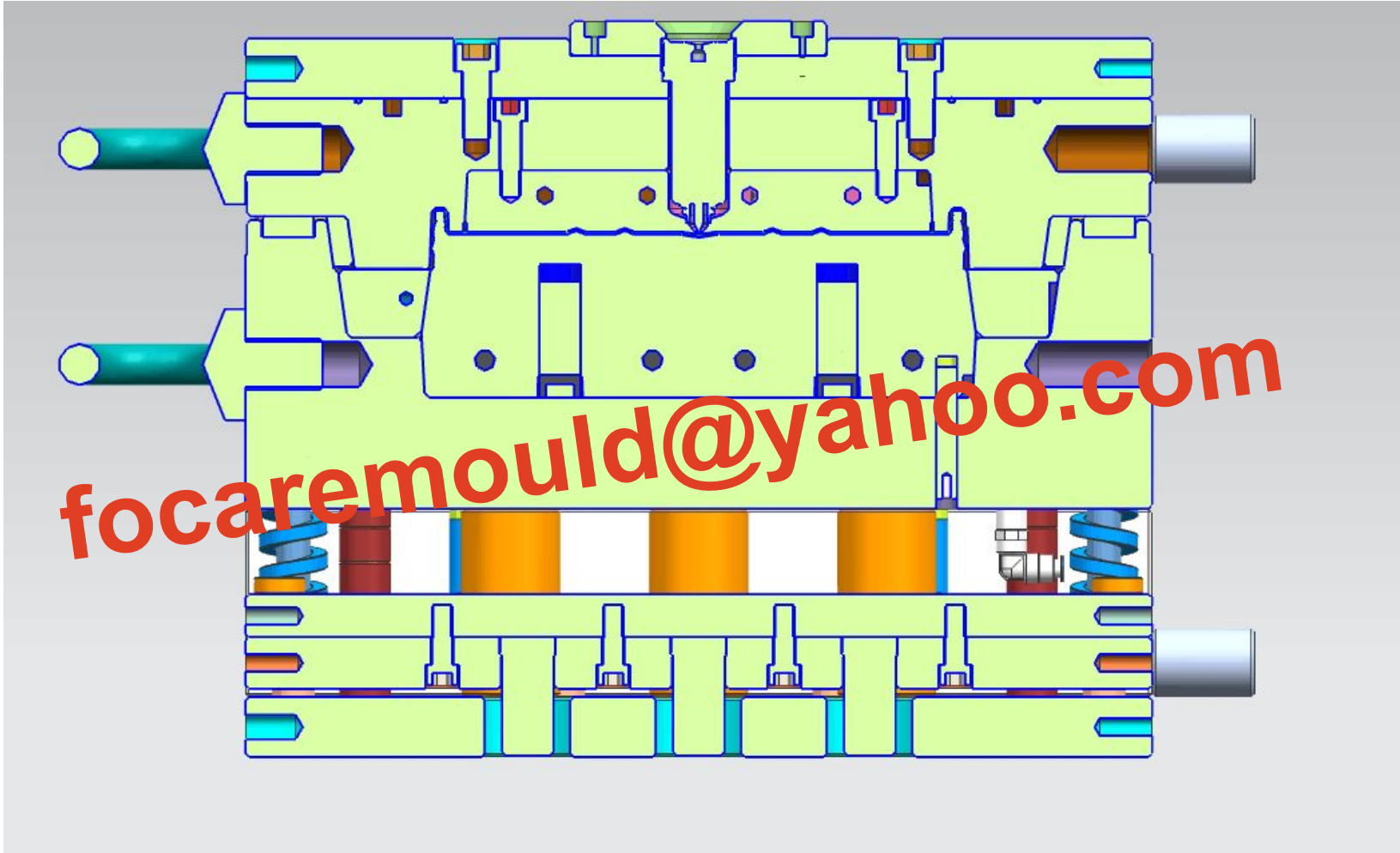

20L paint bucket lid mold



focaremould@yahoo.com

20L paint bucket lid mold

cavity insert

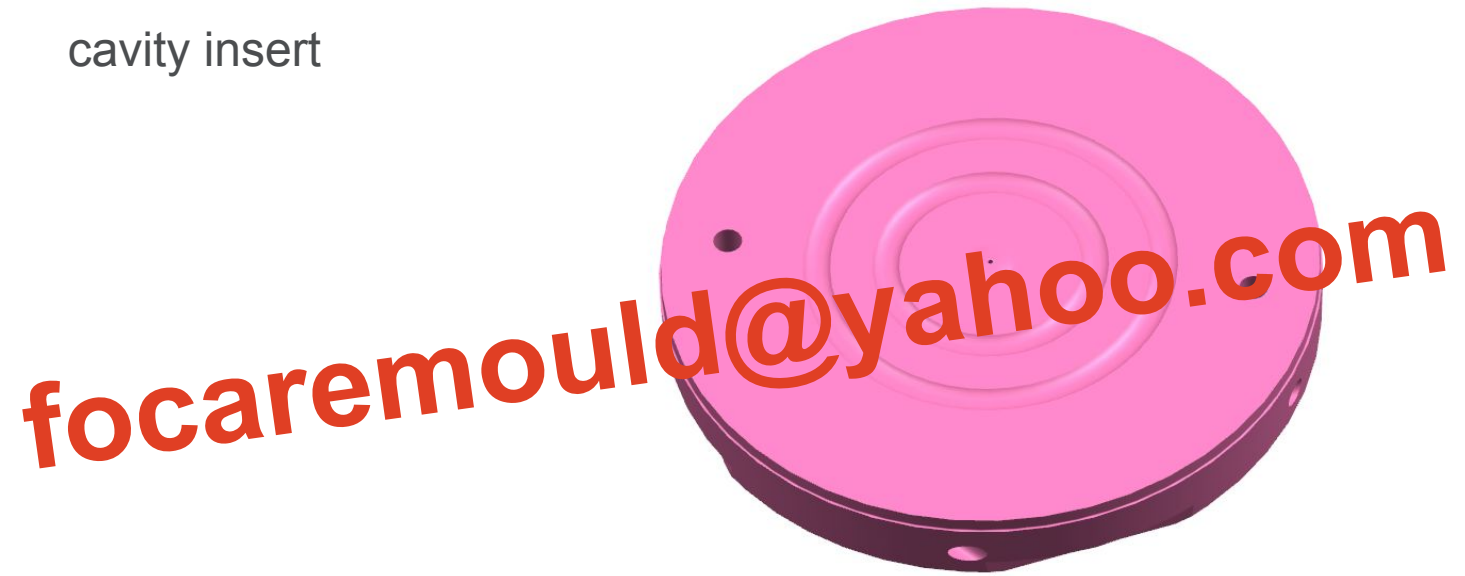

20L paint bucket lid mold

cavity cooling

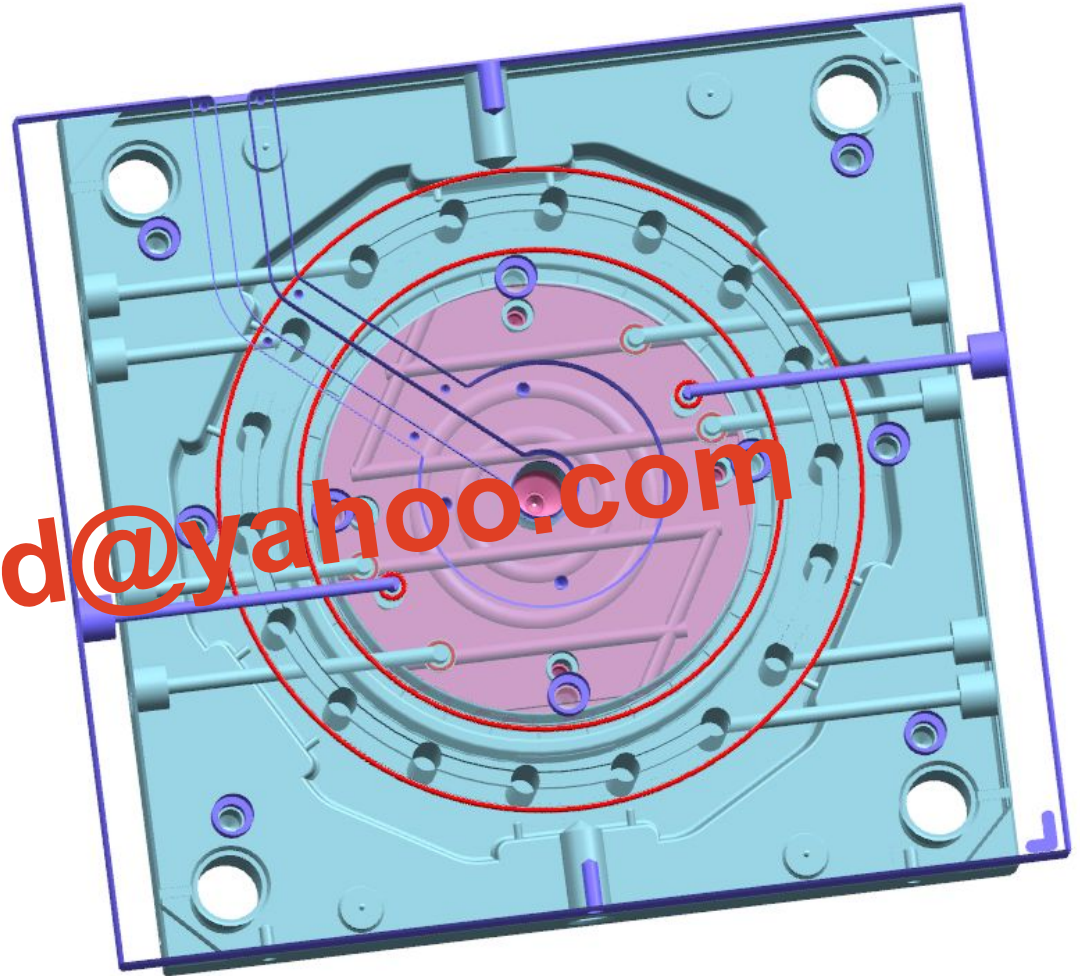

focaremould@yahoo.com

20L paint bucket lid mold

core part

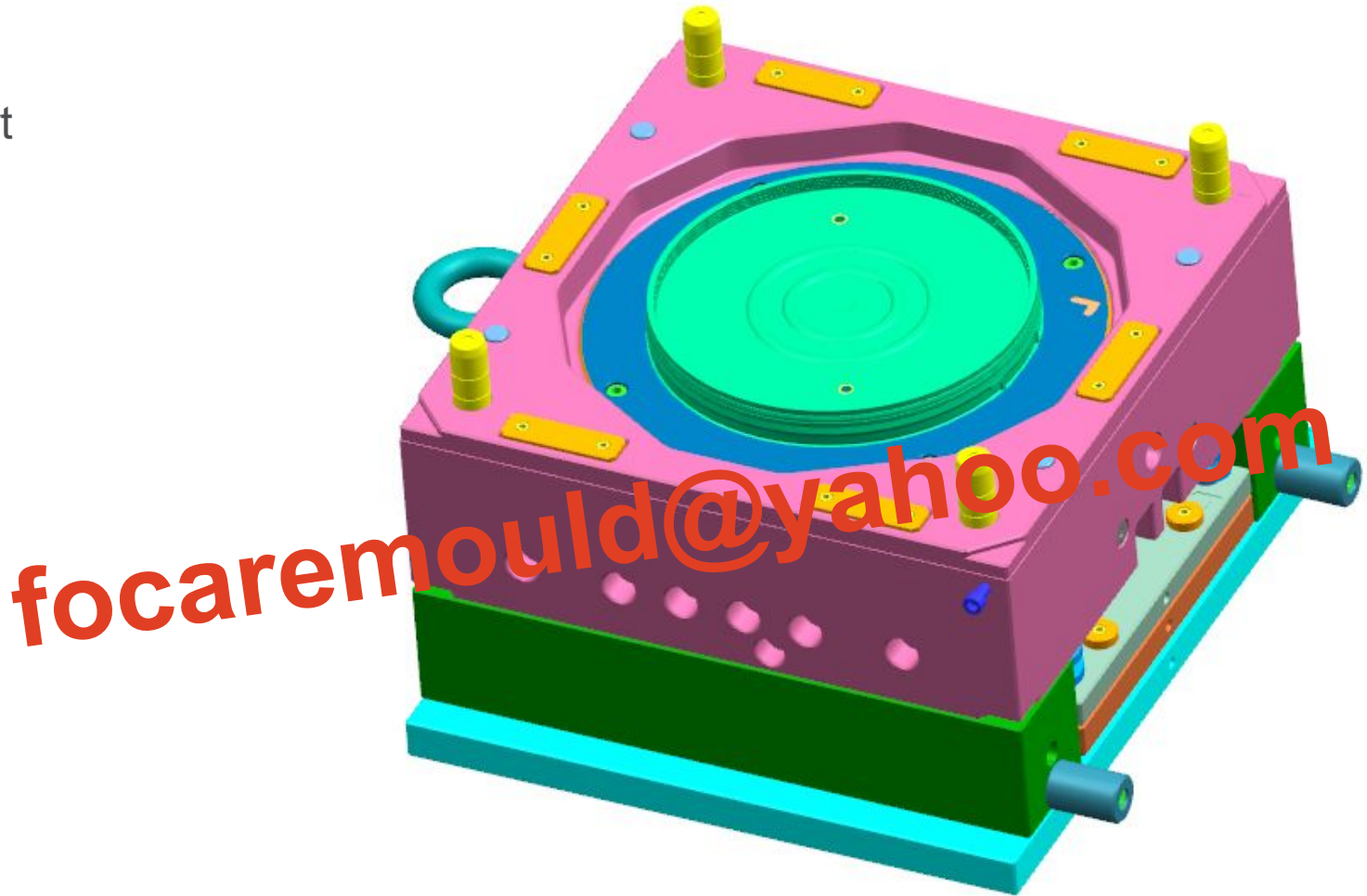

core inserts

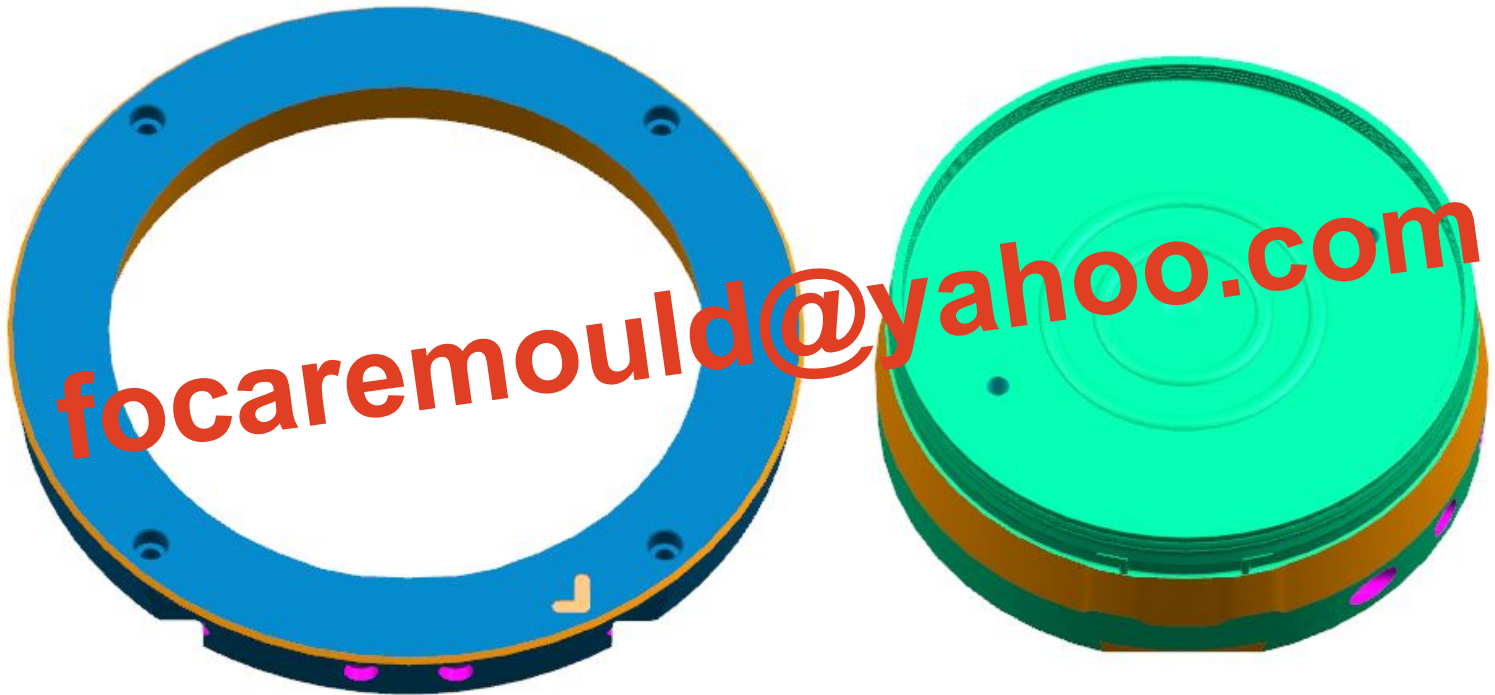

20L paint bucket lid mold

core cooling



focaremould@yahoo.com

handle mold



focaremould@yahoo.com

handle mold

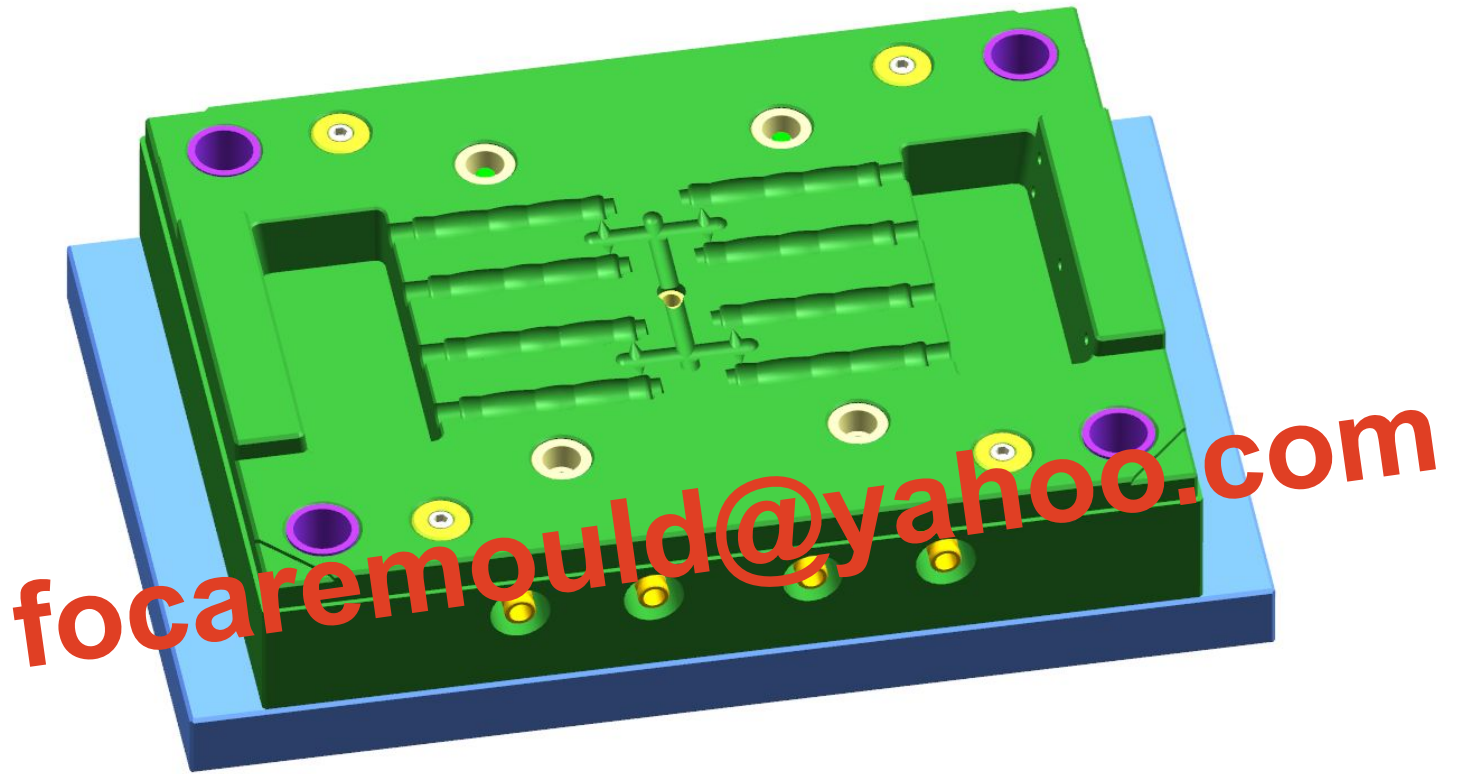

focaremould@yahoo.com

cavity cooling

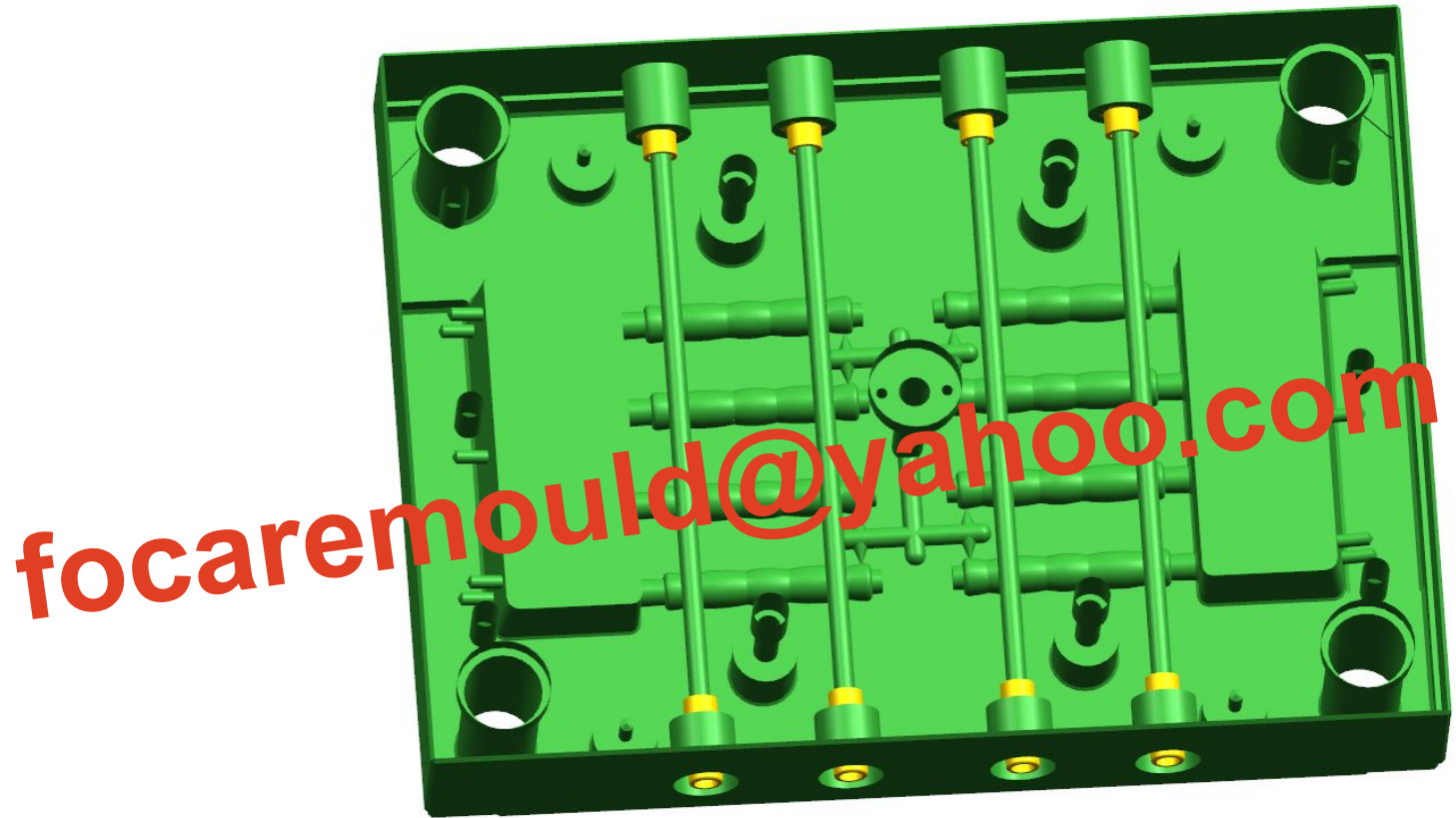

core part

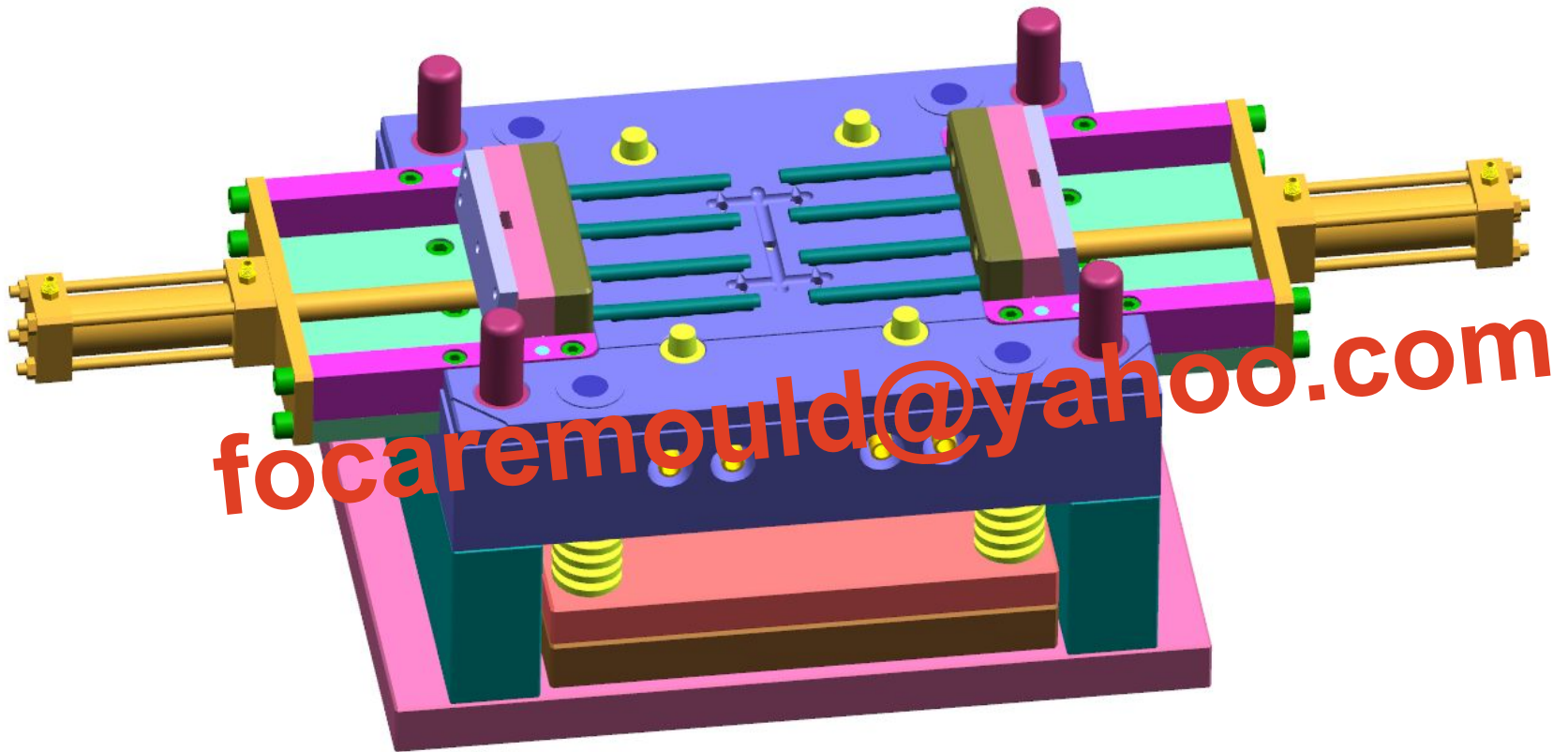

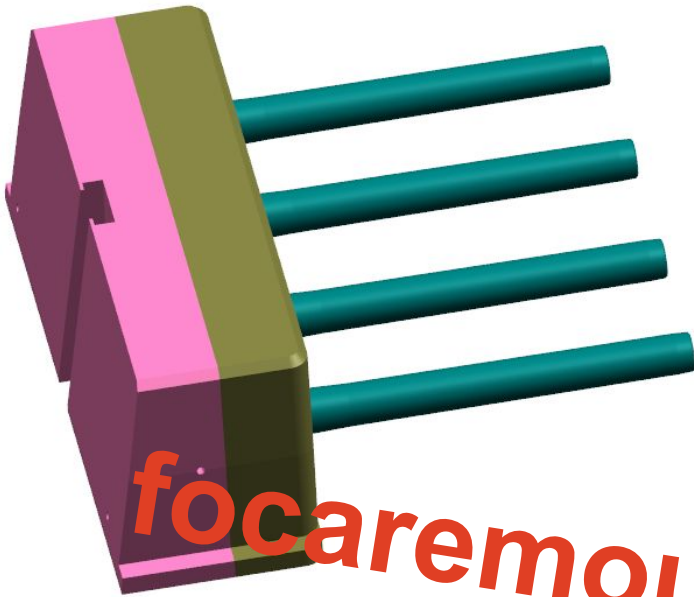

inserts & cooling

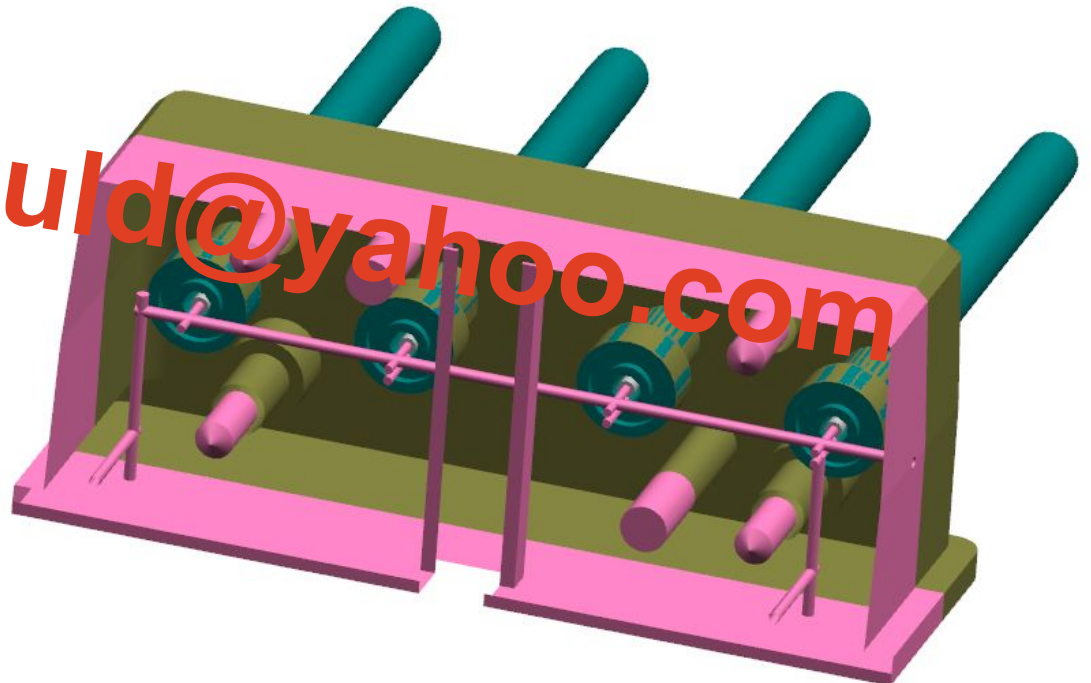

core cooling

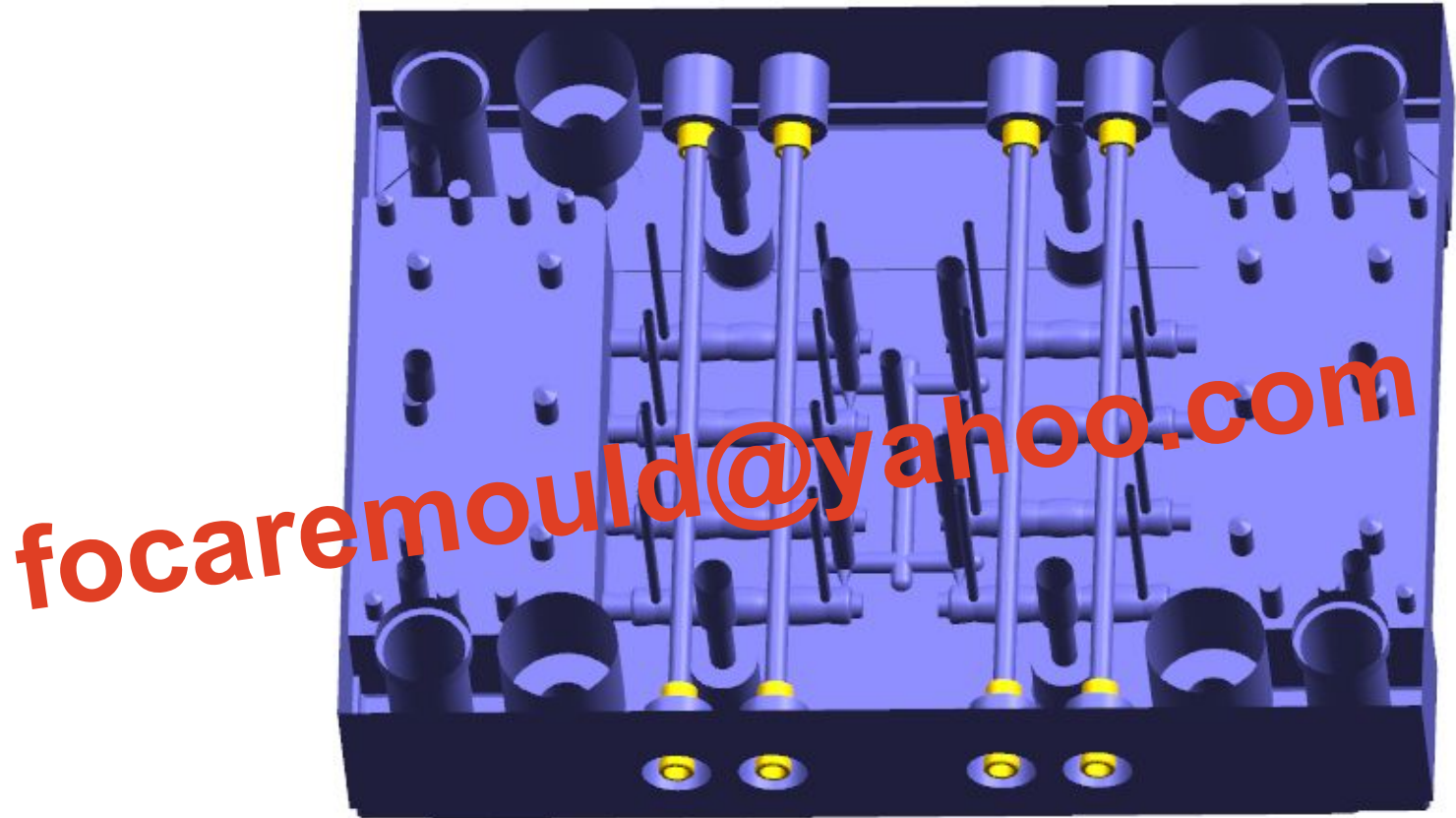

Thank you for your attention!

And welcome your new enquiry!

Lucia

Sales Engineer

+86 18357616586

focaremould@yahoo.com

